

GS EVO 25S4 1150X525

Professional hand pallet truck (2.500 kg)



GS EVO

The GS EVO is the top choice for hand pallet truck: designed for an intensive use with maximum easiness of use and superior ergonomics.

Available in a wide range of options, it is the right tool for customer that is looking for a tailored product for his application or simply a great professional tool.



HYDRAULIC UNIT

The GS EVO pump has been designed with extreme care of details in order to have superior characteristics and features, such as:

- **Monolithic design:** the resistant and reliable one-piece cast iron housing protects all components avoiding any accidental damages. Pump housing is processed with CNC machines to achieve high precision tolerances and high accuracy.
- **Chromed piston rod and oil seal:** in order to avoid rust and prevent oil leakage during the use.
- **Maximum pressure valve:** safety device that protects the transpallet against overloads.
- **PROPORTIONAL LOWERING VALVE:** lowering speed can be proportionally controlled according to the lever position on the tiller. Perfect working tool to carry fragile and delicate loads like crystal, glass and ceramics.



STANDARD CONFIGURATION

- Nylon - Poly 45 steering wheels
- Poly rollers

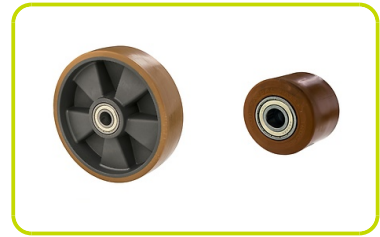

- **Entry/exit rollers.** Supplementary rollers to allow easier entrance and quicker exit from a closed pallet, reducing the impact on the main rollers and guaranteeing a longer life



- **3D Superior Ergonomic shape tiller.** This tiller has a special 3D design, with enhanced ergonomics. Compared to a conventional tiller, this shape allows the operator to have a good position when pushing the loads with maximum efficiency without fatigue. This thanks to two large grasping side areas specifically designed to have a correct position during operation of the truck



PAINTING

Following an appropriate conditioning operation the frame is varnished with polyester powder at a temperature of 250° to guarantee maximum resistance to wear and atmospheric agents.



EASY TO MOUNT

Tiller easy to assemble with a fast mounting system. Robust tiller connection with two full welded joints that assure superior sturdiness in the toughest application.



OPTIONAL CONFIGURATION

- **All types of steering wheels and rollers** (Rubber, Aluminum/Poly, Nylon)



- **Quicklift.** The perfect tool for quick lifting your loads. Saving time and improving efficiency with the specifically designed hydraulic pump. Just two pumps will lift loads under 120kg off the ground or three pumps for loads above 120kg. Compared to 5 pumps with a standard hand pallet truck



- **Covered tiller.** Soft rubber covering grants operator comfort and helps to reduce vibration, enabling a more comfortable and secure grip.



- **Manual control brake.** Made by drum brake on each steering wheel, controlled by dedicated lever on the tiller, it is available with rubber and poly steering wheels. It ensures that the machine doesn't move during parking.



COMPLETE RANGE OF SOLUTIONS (See dedicated GS EVO product card)

- **Capacity.** 3 tons version with reinforced structure for any fork size



- **Silent.** Certified silent version designed to strongly reduce the noise emission even on worse surfaces. This option is suitable for the usage on residential areas deliveries and in supermarket stores



- **Low profile.** Required where the pallet has a limited access due to height. GS EVO can come in low profile with only 55mm height from the ground



- **Galvanized/Stainless steel.** Ideal tool to handle loads in humid and damp conditions. Suitable for environments where high hygienic standards are enforced, such as the chemical, pharmaceutical or food & beverage industry



Description

1.1 Manufacturer			PR INDUSTRIAL
1.3 Drive			Manual
1.4 Operator type			Pedestrian
1.5 Load capacity	Q	kg	2500
1.6 Load centre distance	c	mm	600
1.8 Load axle to end forks	x	mm	932
1.9 Wheel base	y	mm	1192

Weights

2.1 Service weight		kg	63
2.2 Axle load, laden rear		kg	1825
2.2 Axle load, laden front		kg	738
2.3 Axle load, unladen rear		kg	21
2.3 Axle load, unladen front		kg	42

Tyres/Chassis

3.1 Tyres: front wheels			POLY.I./ NYLON
3.1 Tyres: rear wheels			POLY
3.2 Tyre size: Steering wheels - Diameter		mm	200
3.2 Tyre size: Steering wheels - Width		mm	45
3.3 Tyre size: Load rollers - Diameter		mm	82
3.3 Tyre size: Load rollers - Width		mm	60
3.5 Tyre size: rear wheels - Q.ty (X=driven)		nr	4
3.5 Tyre size: front wheels - Q.ty (X=driven)		nr	2
3.6 Tread, front	b10	mm	155
3.7 Tread, rear	b11	mm	375

Dimensions

4.4 Lift height	h3	mm	115
4.9 Height of tiller in drive position max	h14	mm	1185
4.9 Height of tiller in drive position min	h14	mm	710
4.15 Height, lowered	h13	mm	85
4.19 Overall length	l1	mm	1550
4.20 Length to face of forks	l2	mm	400
4.21 Overall width (front/rear)	b1/ b2	mm	525
4.22 Fork dimensions - Thickness	s	mm	55
4.22 Fork dimensions - Width	e	mm	150
4.22 Fork dimensions - Length	l	mm	1150
4.25 Distance between fork arms	b5	mm	525
4.32 Ground clearance, centre of wheelbase	m2	mm	30
4.34 Aisle width	Ast	mm	2048
4.35 Turning radius	Wa	mm	1367

Performance data

5.2 Lifting speed laden	strokes	12
5.2 Lifting speed unladen	strokes	12
5.3 Lowering speed laden	m/s	0.06
5.3 Lowering speed unladen	m/s	0.02

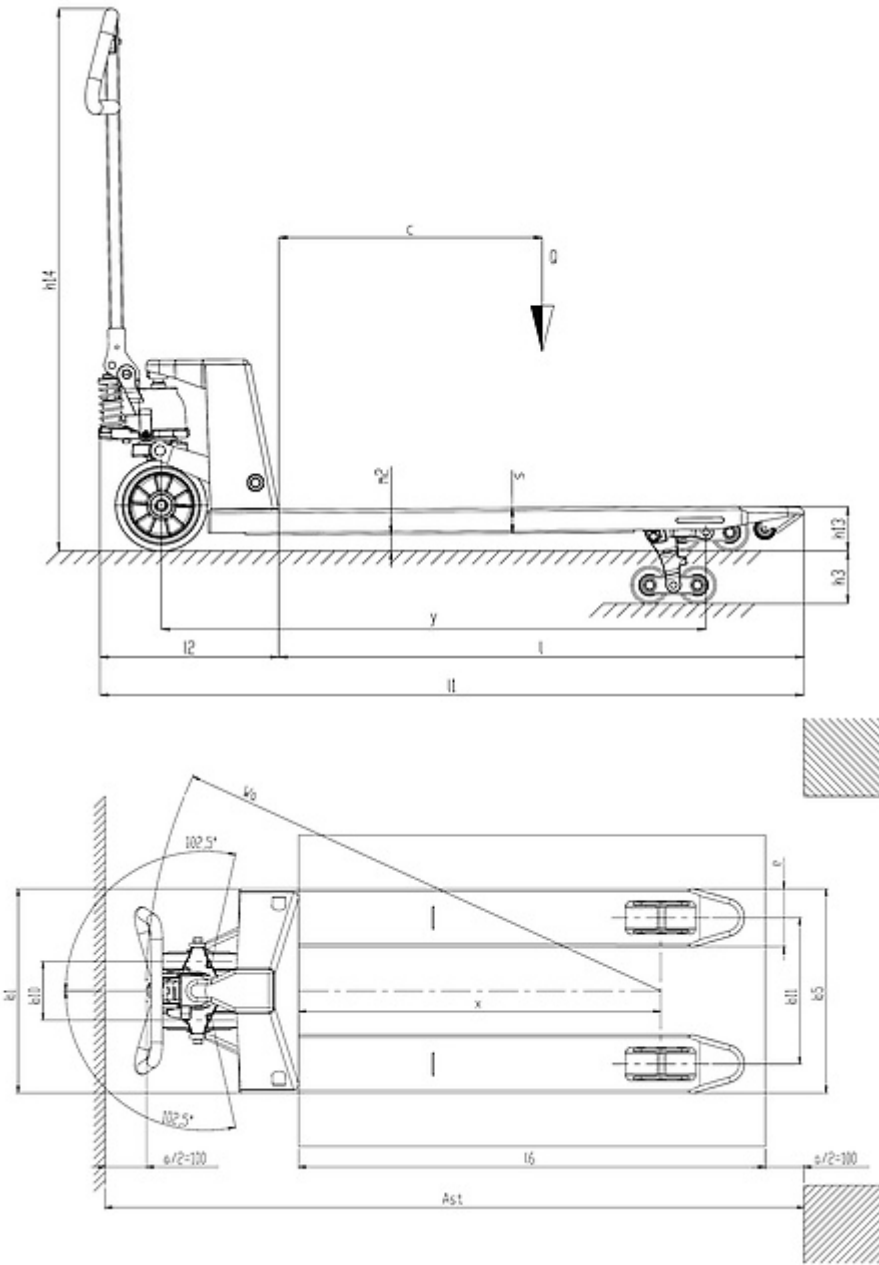

The information is aligned with the Data file at the time of download. Printed on 26/01/2023 (ID 12562)

©2023 | PR INDUSTRIAL s.r.l. | All rights reserved | Image shown may not reflect actual package. Specifications subject to change without notice

